

# 8' X 8' Sound Booth

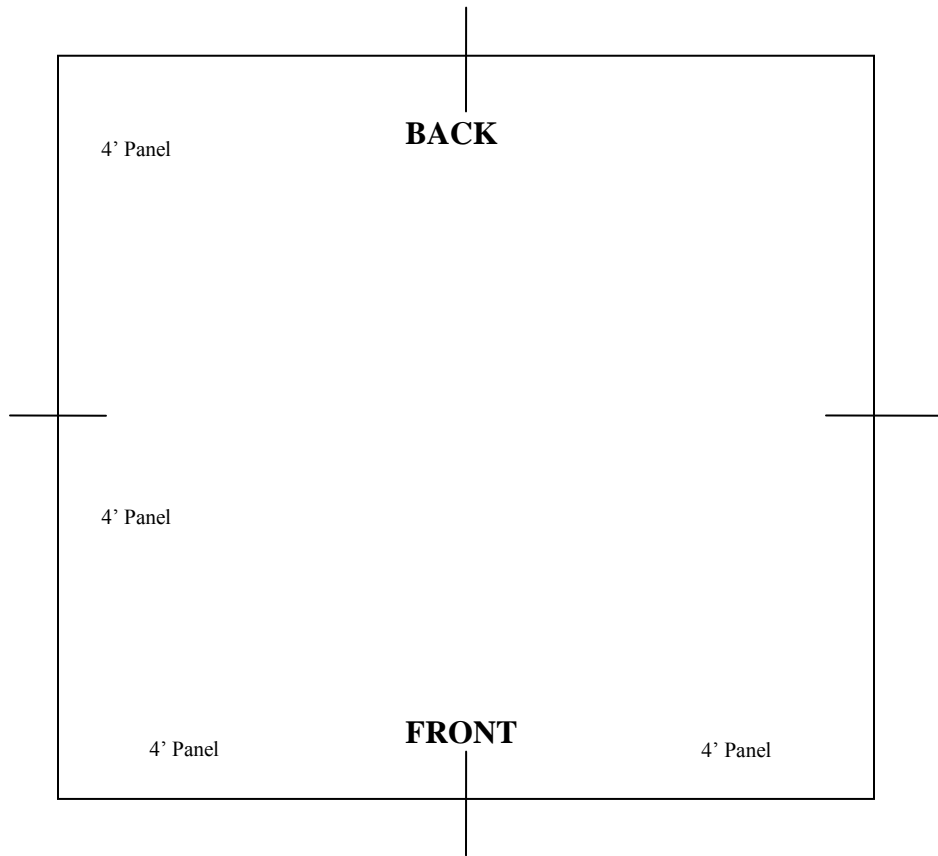

## Example

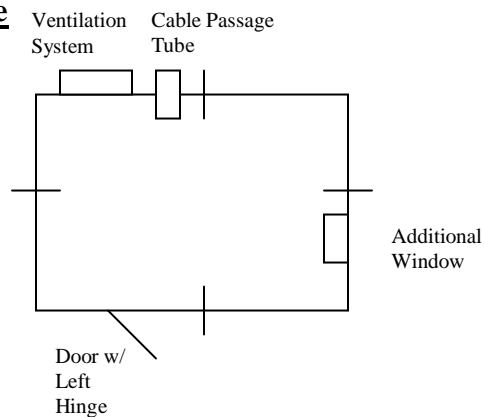

Please Draw on the Diagram where to place the following;

- 1) Ventilation System (Dimensions-24" wide X 70" tall X 6" deep)
- 2) Door Location and Orientation (right of left hinged) Door Size-27" X 75"
- 3) Cable Passage Tube(s)
- 4) Additional Windows (if applicable)
- 5) Jack Panels (if applicable)

**PLEASE FAX BACK TO GRETCH-KEN INDUSTRIES INC. @ 1-541-947-2608**